

Alternative uses of waste heat from large scale biogas power plants in warm climates

Johnmary Migadde, Uganda (PPRE 2012/14)
jmigadde@gmail.com

Abstract: Biogas is generated in largescale biogas plants through a process called anaerobic digestion occurring in digesters. The generated biogas is burnt in an engine to generate both electricity and heat. Over 50% of the primary energy in the biogas is converted into heat. If this heat is not used profitably then this implies that the majority of the primary input energy from the biogas is lost. Therefore, to make large scale biogas power plants economically viable, the waste heat needs to be used economically to generate income so as to supplement that obtained from the sale of electricity. This paper presents an investigation of some selected uses of waste heat from biogas power plants. Simulation plant models using a simulation software called *Cycle Tempo* were developed. Performance data from three biogas power plants located in Northern Germany was collected and analysed and this data then formed the input for the simulation plant models used in the analysis. Different configurations of the selected uses have been simulated using the simulation models depending on the heat quality and quantity of the waste heat. The models use climate parameters of warm climate countries (Uganda in particular) to arrive at the final results.

1 Introduction

Anaerobic digestion is one of the conversion technologies for biomass in which organic matter is decomposed by micro-organisms to generate biogas. Biogas consists of mainly methane (CH_4) (whose percentage content depends on the type of organic matter) and carbon dioxide (CO_2). It also contains small quantities of: Water (H_2O), Nitrogen (N_2), Ammonia (NH_3), Oxygen (O_2) and Hydrogen Sulphide (H_2S). This process takes place on a large scale in enclosed compartments called fermenters or digesters. Biogas can be used for a number of applications that include: providing heat when burnt in a boiler; generation of heat and electricity when burnt in a Combined Heat and Power Plant (CHP); it can also be reconditioned by removal of CO_2 so that the resultant gas is used in fuel cells to generate heat and electricity for domestic and industrial consumption or for propulsion in vehicles; conditioned gas can also be fed into the natural gas grid as bio-methane.

When biogas is burnt in a CHP plant, both electrical and heat energy are generated. On average 10% of the primary energy in the biogas is lost to the environment, 35% is converted into electricity and 55% is the usable heat (Rutz, 2012). Out of the usable heat, 50 - 60% is released in the exhaust flue gases at 80°C to 550°C , 30 - 40% is discharged in the engine cooling water at

80°C - 90°C, 1- 3% is released in the engine lubricating oil at 80°C - 90°C and 3- 5% is lost in form of radiation. If this heat energy is not put to use then over 55% of the primary energy in the biogas is put to waste which can have economic and technical implications. *“The energy exhausted to the atmosphere is energy that has been paid for and which should not be discarded until the last penny of profit has been extracted”* (Stecher, 1979)

Large scale biogas power plants have been built in cold climate countries such as Germany. However, little has been done to build similar large scale power plants for electricity and heat generation in warm climate countries such as those in Sub-Saharan Africa, despite the availability of a lot of biomass resources. This could partly be attributed to the fact that they are viewed as not being economically feasible or that sufficient information about their operation in warm climates is not exactly known. In order to increase their economic feasibility, the generated waste heat has to be used for purposes from which income can be obtained.

2 Methodology

2.1 Waste Heat Recovery

Waste Heat is heat generated in a process but then dumped to the environment even though it could still be re-used for useful and profitable purposes (Stecher, 1979). In order to use waste heat, two factors have to be known about it; heat quality and heat quantity. Heat quality is the measure of the usefulness of a given heat stream based on its temperature. Heat quality characterises the usefulness of a given heat stream based on the temperature at which the heat is given off. Different applications need heat of different qualities. For example: hot water supply and residential heating needs 50 - 80°C, drying of agricultural products needs 60 - 150°C, Organic Rankine Cycle (ORC) machines need 60 - 560 °C (Rutz, 2012). The temperature of the heat source needs to always be higher than the sink. A precise knowledge of the quality of waste heat is therefore of paramount importance because it helps to identify the appropriate usage of the heat. Heat quantity is a measure of the amount of energy contained in a given heat stream. The heat quantity or content in a heat stream is a function of the mass flow rate and the temperature of the stream. It can be calculated from equation 1 below:

$$E = \dot{m}h(t) \tag{1}$$

Where: E is the energy in Watts, \dot{m} is the waste stream mass flow rate (kg/s) and $h(t)$ is the waste heat enthalpy (J/kg) and is a function of temperature.

2.2 Heat recovery applications investigated

There are a number of heat recovery applications however, only the following were investigated: organic rankine cycle, greenhouses, drying digestate and absorption cooling.

2.2.1 Organic Rankine Cycle

Organic Rankine Cycle (ORC) machines make use of organic fluids as the heat transfer medium instead of water which is used in the traditional rankine cycle machines. Heat recovery by ORC can be indirect or direct. Direct heat recovery occurs where the source of heat is a liquid and a heat exchanger is used to transfer heat between the hot liquid source and the organic fluid. Indirect heat recovery occurs if the heat source is a gas and hence an intermediate medium, usually thermal oil or pressurised water is used to transfer heat to the organic fluid. The recovery system should be separable from principle heat source so that if it fails, the primary process is not affected. Also a redundant cooling system can be put on standby in case the primary process needs cooling.

2.2.2 Green houses

Greenhouses are enclosed shelters made of glass or plastic where food can be grown under controlled conditions throughout the year. Waste heat from biogas power plants can be used as a source of heat for these greenhouses throughout the year. Water heating circuits and air heaters are the two methods used to introduce heat into greenhouses. Plants grown in greenhouses usually require temperatures between 20 - 25°C and a yearly heat demand of 600kWh per m² (Rutz, 2012). The heat transfer coefficient of the greenhouse enclosure varies from 4.6 (double glazed houses) to 10 (simple foil) (Rutz, 2012). The carbon dioxide realised from the flue gases can also be used by the plants. Enrichment with carbon dioxide increases plant yield by up to 40%. However, the carbon dioxide from the flue gases needs to be run first through a catalytic converter purification unit (Nixon Energy, 2014). Green houses require fresh air to be supplied so as to remove warm moisture-laden air from within the greenhouse. If it is not removed, excessive condensation and high humidity occurs. Humidity over 90% leads to rapid development of leaf mold and fruit and stem rot (Dennis E . Buffington, 2013). Therefore, ventilation systems are important in greenhouse operation. Ventilation can occur naturally due to convection or forced by using fans utilising electricity.

2.2.3 Drying digestate

Digestate is the name given to substrate after undergoing anaerobic digestion in fermenters. The digestate can then be used as a fertiliser when applied to the fields. Digestate contains 5 to 15% Dry Matter (Peschel, 2008). Digestate requires huge storage volumes. However, if the water is filtered out and then the remaining solid digestate is dried, then the resulting digestate pellets can be stored in a smaller volume. The drying principle is such that digestate is fed into the dryer with a Dry Mass (DM) content of 25% to 50% and then optimally distributed. Waste heat from the CHP plant is then used to heat cold air through heat exchangers. The warm air is then drawn across the chamber by use of fans. The belts are usually perforated so that the hot air does not only go over the digestate but also through it. The storage period in the drying chamber can be 1 or 2 days before the material is ready. The output dry digestate has a DM content of 85 to 90% (Peschel, 2008).

There are two methods of digestate processing. They include: Separation and back-mixing. Separation involves using a screw press to remove the water before the digestate is fed onto the drier belt. With back-mixing the removal of water using a screw press is not necessary. However, the fluid digestate is mixed with already dried digestate in a back mixing unit.

2.2.4 Absorption Cooling

Cooling can be achieved by use of waste heat through a process known as absorption cooling. Absorption cooling utilises the excess heat to provide energy to drive the cooling process. Instead of using a compressor to provide mechanical work, a combination of absorber and refrigerant re-generator is used with little mechanical work from a small pump used to maintain circulation. Absorption chillers are an alternative to regular compressor chillers where electricity is unreliable, costly, or unavailable, where noise from the compressor is problematic, or where surplus heat is available as it is the case of biogas power plants.

2.3 Simulation of heat uses

Performance data used for simulation of heat uses was obtained from three biogas plants located in Germany. The climate conditions used were those of a warm climate location namely Mbarara district in Uganda with coordinates (-0.6N, 30.7E). The weather data was obtained from *RETSCREEN* and *soda-is.com*. This weather data is used for calculation of the solar gains and is also used as a source for the ambient conditions. The details of the biogas plants used are shown in table 1. Simulations were done for organic rankine cycle, greenhouses, drying digestate and absorption cooling.



Table 1: Details of biogas plants used

Specification	PLANT A	PLANT B	PLANT C
Installed electrical Capacity (kWe)	265	625+265	347+190
Installed thermal output (kW _{th})	300	438+273	520
Electric energy (kWh d ⁻¹)	5,980	12,000	10,000
Thermal energy (kWh d ⁻¹)	n/a	9,000 ¹	n/a
Biogas production(Nm ³ m ⁻³ AVd ⁻¹)	2,800	6301	5,480
Reactor volume (m ³)	1800	3900	4000
Operating volume (m ³)	1700	3400	n/a
Gas tank volume (m ³)	1114	n/a	1000
Digester temperature (m ³)	40	40	40 - 50
Substrate (ton/day)/ (ton/year)/ (%)			
Amount of digestate (ton/year)	5,900	15,000	12,000
Digestate Dry mass (% FM)	8	8	8









2.3.1 Organic rankine cycle (ORC)

Using operating conditions from the three biogas plants, organic rankine cycle simulations were done. The operating conditions used are shown in table 2 and table 3.

Table 2: Operating conditions for ORC simulations

No.	Apparatus	Operating Conditions			
		Plant A	Plant B	Plant C	
1.	 Biogas plant	Pout (bar)	0.045	0.045	0.045
		Tout (°C)	30	30	30
		DELM (kg/s)	0.0275	0.08022 (625kWe) and 0.0366(265kWe)	0.04888 (347kWe) and 0.0275 (190kWe)
		LHV (kJ/kg)	19100	19100	19100
2.	 Combustion air source	Pout (bar)	1.013	1.013	1.013
		Tout (°C)	50	50	50
		SUBTYP	0	0	0
3.		EEQCOD	1	1	1
		DELP (bar)	0.5	0.5	0.5

¹ For the 625kWe plant only

		DELE (kW)	70	153.2(625kWe) and 70(265kWe)	93.36(347kWe) and 52.53 (190kWe)
		LAMBDA	1.95 – 3.5	1.95 – 3.5	1.95 – 3.5
		TREACT (°C)	1100	1100	1100
		PREACT (bar)	11	11	11
Gas engine part 1					
4.		TUCODE	0	0	0
		GDCODE	1	1	1
		Tout (°C)	550	550	550
		ETHAM	0.85	0.85	0.8
Gas engine part 2					
5.		ETAGEN	0.952	0.952	0.952
Generator 1					
6.		EEQCOD	1	1	1
		DELP1 (bar)	1	1	1
		DELE (kW)	0.5	0.5	0.5
		DELP2 (bar)	2	2	2
		DELTL (°C)	160	160	160
		DELTH (°C)	305	305	305
economiser					
7.		PIN (bar)	1.013	1.013	1.013
Stack					
8.		EEQCOD	1	1	1
		DELP1 (bar)	0.05	0.05	0.05
		DELE (kW)	0.5	0.5	0.5
		DELP2 (bar)	2	2	2
		DELTL (°C)	120	120	120
		DELTH (°C)	5	5	5
Transfer fluid heat exchanger					
9.		POUT (bar)	10	10	10
		DELT (°C)	0.5	0.5	0.5
		ETHAM	0.85	0.85	0.85
Thermal Oil circulation pump					
10.		POUT (bar)	7	7	7
		DELT (°C)	0	0.5	0.5
		ETHAM	0.85	0.85	0.85
Heat transfer fluid circulation pump					







11.	 ORC turbine	TUCODE	0	0	0
		GDCODE	1	1	1
		TOUT	160	160	160
		ETHAM	0.95	0.95	0.95
12.	 Regenerator	EEQCOD	-	-	-
		DELP1 (bar)	0.5	0.5	0.5
		DELE (kW)	0.5	0.5	0.5
		DELP2 (bar)	0.05	0.05	0.05
		DELTL (°C)	60	60	60
		DELTH (°C)	45	45	45
		RPSM	1	1	1
13.	 Condenser	EEQCOD	-	-	-
		DELP1 (bar)	0.5	0.5	0.5
		DELE (kW)	0.5	0.5	0.5
		DELP2 (bar)	0.005	0.005	0.005
		DELTL (°C)	30	30	30
		DELTH (°C)	45	45	45
		RPSM	1	1	1
14.	 Generator 2	ETAGEN	0.98	0.98	0.98
15.	 Cooling water circulation pump	POUT (bar)	8	8	8
		ETHAM	0.85	0.85	0.85
		DELT (°C)	0.5	0.5	0.5
16.	 Cooler	DELP (bar)	1	1	1
		TOUT (°C)	60	60	60

Table 3: Operating conditions for pipes used

Pipe No.	Liquid type
1	Gas fuel (biogas)
2	Combustion input air
3,4,5,18	Flue gases from engine
6,7,8	Thermal oil (down thermal J)
9,10,11,12,13,17	Heat transfer fluid (toluene)
14,15,16,19,20,21	Cooling water

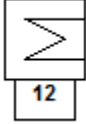
The simulation diagram used is showed in figure 1. It consists of a biogas power plant that burns biogas to generate electricity and flue gases. The flue gases are then used to heat up a connected ORC plant.

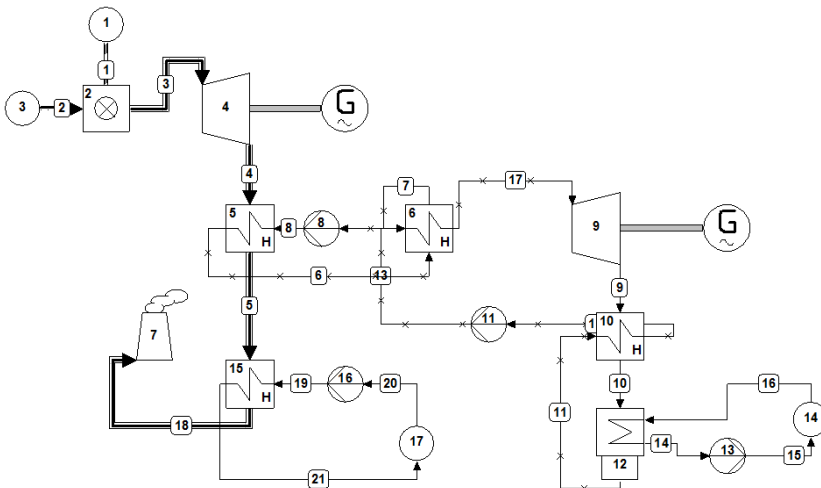

Figure 1: Simulation model with biogas plant and ORC

2.3.2 Green house usage

The model used for analysis of a greenhouse is shown in figure 2. Heat demand analysis for greenhouses was done for warm climates based on assumptions in figure and table 4.

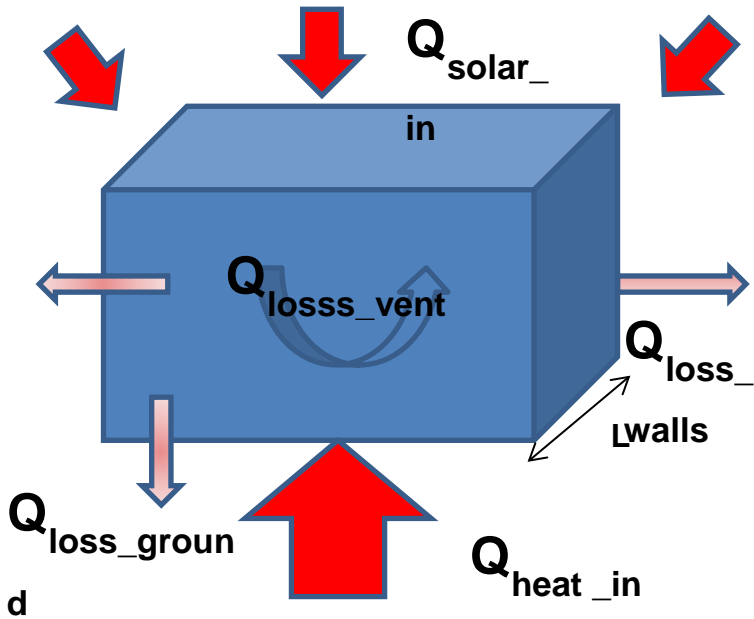

Figure 2: Model for greenhouse Analysis

Table 4: Assumptions taken for greenhouse energy balance

Assumption	Value	Source
Shape of green house	Rectangular solid shape	Own assumption
A constant temperature inside the greenhouse	21°C (temperature favourable for growing vegetables, tomatoes in particular)	(R.Andrews, 2011),
Density of air at 21°C	1.2kg/m ³	Standard value
Specific heat capacity of air at 21°C	1.0 kJ/kg	Standard value
Heat transfer coefficient of double glazed glass	4Wm ⁻² k ⁻¹	(R.Andrews, 2011)
Solar transmission coefficient constant, τ	0.7	(R.Andrews, 2011)
Solar absorption coefficient, γ	0.3 – 0.7 (chosen 0.7)	(Druma, 1998)
Winter ventilation rate	2 Air changes ² per hour	(Dennis E . Buffington,

² An air change is equivalent to the volume of air occupying the greenhouse at an instant

		2013)
Summer ventilation rate	One air change per minute	(Dennis E . Buffington, 2013)
Autumn and Summer ventilation rates	Half way between winter and summer rates	(Dennis E . Buffington, 2013)
Average annual ground temperature at 1m in cold climate countries	10 - 13°C (average 10.3)	Alliant Energy .com (NASA database for Emden)
Average annual ground temperature at 1m in warm climate countries	20.8°C	NASA database for Mbarara, Uganda
soil thermal conductivity	1.52Wm ⁻¹ K ⁻¹	(Druma, 1998)

The energy balance of the green house is calculated as shown in equation 2 based on figure 2.

$$\dot{Q}_{heat_{in}} = \dot{Q}_{loss_{ground}} + \dot{Q}_{loss_{walls}} + \dot{Q}_{loss_{vent}} - \dot{Q}_{solar_{in}} \quad (2)$$

Where: $\dot{Q}_{heat_{in}}$ is the heat that should be supplied from the exhaust of the gas engine (W), $\dot{Q}_{loss_{ground}}$ is the heat lost to the ground (W), $\dot{Q}_{loss_{walls}}$ is the heat loss through the walls (W), $\dot{Q}_{solar_{in}}$ is the heat gains from the incoming solar radiation (W), $\dot{Q}_{loss_{vent}}$ represents ventilation losses (W),

2.3.3 Drying digestate

In the analysis the following assumptions are considered:

- 1 MWh_{th} of heat energy evaporates 1 ton of water from digestate. (Stela.LaxhuberGmbH, 2014).
- The technology used is back mixing, whereby some of the already dry digestate is mixed with the fresh digestate so as to increase its dry matter (DM) content to at least 20% DM (%FM).
- The desired DM content of the dried digestate is 85%.
- The input digestate has a DM of 8% (% of FM) (Deland biogas farmers).

Procedure of calculations:

- The initial amount of water content of the digestate is derived from the equation below

$$\text{Water Content (WC)} = \text{Fresh Mass (FM)} - \text{Dry Mass(DM)} \quad (3)$$

- Variations are done for resulting percentages of DM content of the FM achieved through back mixing to achieve DM contents of 23.4%, 33.7%, 16.5%, 27.2%, and 46.5%.

The resulting water content of the digestate before feeding into the driers is calculated and is shown in Table 5. This is the annual amount of water that needs to be evaporated from the resultant back mixed digestate per plant. Table 6 shows the annual energy demand required to evaporate the water from digestate per plant. The heat energy requirements are simulated using the model in figure 3.

Table 5: Properties of the digestate to be dried per plant

Plant Name	WC to be removed (DM- 23.4%) (ton)	WC to be removed (DM- 33.7%)(ton)	WC to be removed (DM- 16.5%) (ton)	WC to be removed (DM- 27.2%)(ton)	WC to be removed (DM- 46.5%)(ton)
Plant A	5417.18	5416.82	5410.43	5417.34	5429.14
Plant B	13588.24	13587.35	13571.30	13588.65	13618.24
Plant C	10870.59	10869.88	10857.04	10870.92	10894.59

Table 6: Annual energy demand to evaporate water from digestate per plant

Plant Name	Energy demand (DM- 23.4%) (MWh)	Energy demand (DM- 33.7%) (MWh)	Energy demand (DM- 16.5%) (MWh)	Energy demand (DM- 27.2%) (MWh)	Energy demand (DM- 46.5%) (MWh)
Plant A	5417.18	5416.82	5410.43	5417.34	5429.14
Plant B	13588.24	13587.35	13571.30	13588.65	13618.24
Plant C	10870.59	10869.88	10857.04	10870.92	10894.59

2.3.4 Absorption cooling

The storage life of perishable foods such as fish, vegetables and animal products can be extended for a few days by refrigerating them at temperatures

a little higher than freezing temperatures, usually between 1 to 4°C. However, the storage life can even be further increased if they are stored at sub-zero temperature in the range -18°C to - 35°C.

To estimate the demand for absorption cooling, the following assumptions are made as listed in table 7.

Table 7: Absorption cooling simulation assumptions

Assumption	Value	Source
Double effect chiller	COP = 1.2 at 180°C	(IEA, 2012)
Single effect chiller	COP = 0.7 at 90°C	(IEA, 2012)
The product to be cooled is milk	Density at 20°C is 1030kg/m ³	(Earle, 1966)
	Specific heat capacity at 20°C is 3.9kJ/kg.K	(Earle, 1966)
	Cooling done up to 4°C	(Earle, 1966)

The energy extracted from the cooling milk is calculated using the assumptions in table 7 (COP, density, initial temperature of 20°C and final cooling temperature of 4°C) . The input energy requirements are estimated for different volumes of milk. Table 8 shows the results of this calculation. The heat energy requirements are simulated using the model in figure 1.

Table 8: Energy Requirements for absorption cooling

Amount of milk per day (litres/day)	Amount of milk per day (m ³ /day)	Amount of Milk (m ³ /s)	Heat energy extracted from milk per hour (kWh)	Heat Energy demand at COP 1.2 per hour (kW)	Heat Energy demand at COP 0.7 (kW)
1,000	1	0.00028	17.9	14.9	25.5
3,000	3	0.00083	53.6	44.6	76.5
5,000	5	0.00139	89.3	74.4	127.5
7,000	7	0.00194	125.0	104.1	178.5
10,000	10	0.00278	178.5	148.8	255.0
15,000	15	0.00417	267.8	223.2	382.6
20,000	20	0.00556	357.1	297.6	510.1
25,000	25	0.00694	446.3	371.9	637.6
30,000	30	0.00833	535.6	446.3	765.1

3 Results

After performing the various simulations and calculations, the results obtained were as follows:

3.1 Simulation results of the different uses

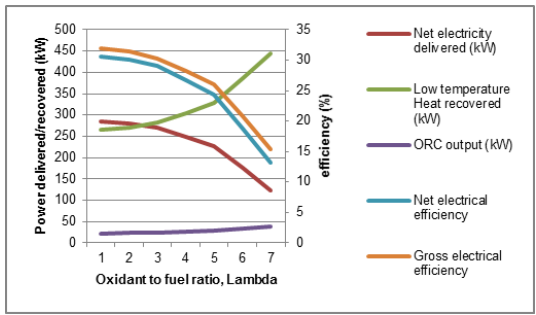
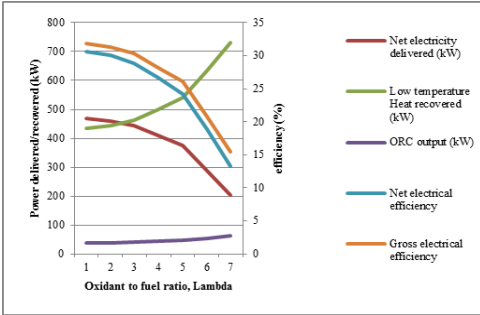

Figure 4a: ORC output combined with additional heat recovery (625kWe plant)

Figure 4b: ORC output combined with additional heat recovery (347kWe plant)

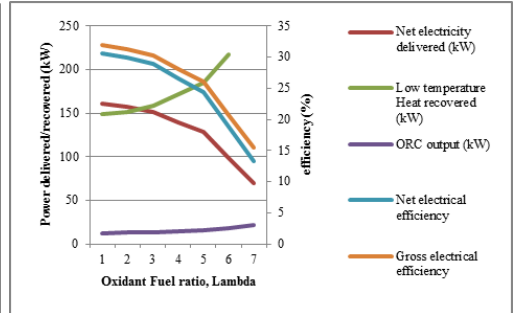
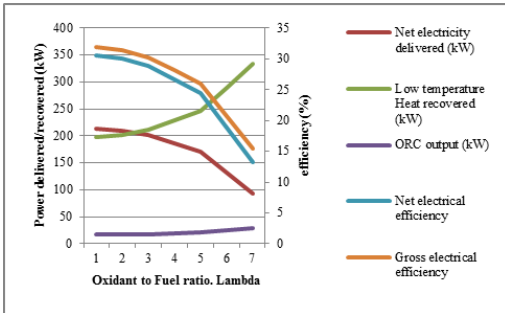

Figure 5a: ORC output combined with additional heat recovery (265kWe plant)

Figure 5b: ORC output combined with additional heat recovery (190kWe plant)

3.1.2 Greenhouses

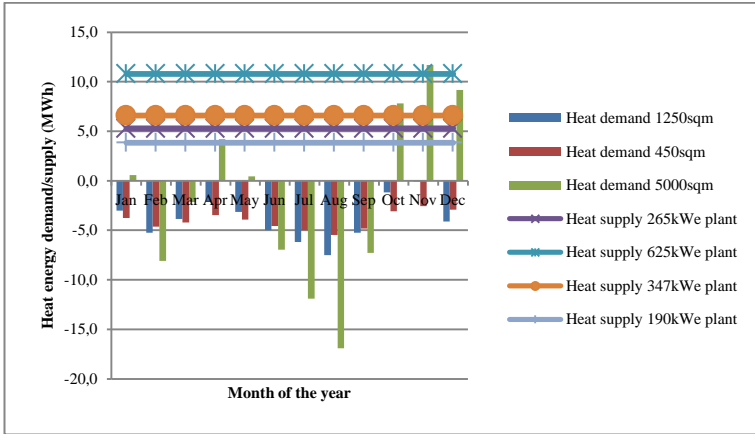

Figure 6: Daily heat demand of greenhouses and supply of plants in warm climates

3.1.3 Absorption cooling

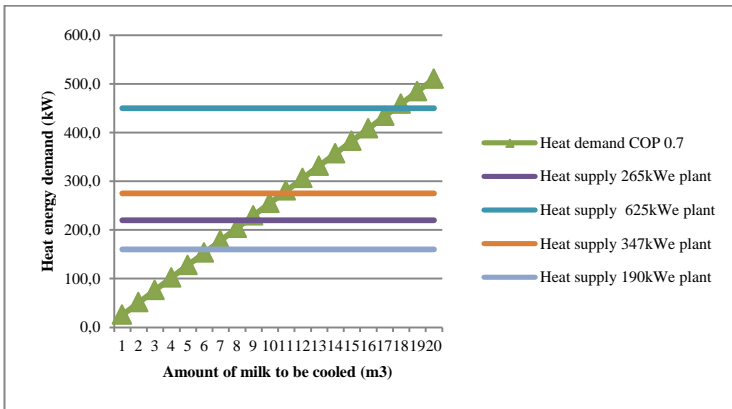

Fig. 7: Heat energy demand for milk cooling verses the amount of milk cooled

3.1.4 Drying digestate

Table 9: Comparison between heat demand and supply for drying digestate

Plant Name	Heat demand (DM-23.4%)	Heat demand (DM-33.7%)	Heat demand (DM-16.5%)	Heat demand (DM-27.2%)	Heat demand (DM - 46.5%)	Annual Heat supply (MW)
Plant A	5417.18	5416.82	5410.43	5417.34	5429.14	1760
Plant B	13588.24	13587.35	13571.30	13588.65	13618.24	5360
Plant C	10870.59	10869.88	10857.04	10870.92	10894.59	3800

3.2 Discussion

3.2.1 ORC Rankine Cycle

Organic Rankine Cycle was used to recover high quality heat and convert it into additional electricity. Further, low heat quality heat from other areas of the engine (oil and water cooling circuits modelled by the downstream heat exchanger) as well as from ORC system was recovered and is modelled by condenser downstream. Figures 4a, 4b, 5a and 5b show that there is an optimum lambda at which the electricity generated and the heat energy generated are equal. Lambda is used to vary the power to heat ratio of a biogas plant engine. By increasing Lambda beyond the optimum value (that gives equal heat and power) the share of waste heat generated is increased but at the expense of a dropping electrical output. When Lambda is lowered, more electricity can be generated at the expense of a reduction of heat output, keeping the biogas flow rate constant.

3.2.2 Greenhouse

Figure 6 shows that the greenhouses in warm climate countries need very little heating; mainly in the night of some months of the year. Instead cooling is needed for most of the day except at night. (21°C was assumed as the greenhouse temperature). Therefore, either a material with a low solar transmission coefficient could be used for the greenhouse structure enclosure or cooling fans need to be used (this increases electricity consumption). A collector system can be integrated with the green houses so as to heat water

with the excess heat due to the incoming solar irradiation. The water can be used for other domestic purposes. In addition, sunshine shields or reflectors can be used.

3.2.3 Absorption cooling

From figure 7, the following can be derived:

- The heat from a 190kWe plant engine can supply enough heat to cool 5700 to 6800 litres of milk.
- Heat from a 265kWe plant engine can cool 7800 to 9000 litres of milk.
- Heat supply from a 347kWe plant engine can be used to run a chiller to cool 10000 to 13000 litres of milk.
- Heat from a 625kWe plant engine can be used to supply an absorption chiller to cool 17000 to 18000 litres of milk.

3.2.4 Drying digestate

The heat from the four engines is not sufficient to supply all the heat required to dry the digestate to 85% DM per year. Therefore less than 50% of digestate can be dried using back filling method. In order for this heat energy to be sufficient, the water needs to be squeezed out using a screw press prior to drying.

4 Conclusion

The heat demand for selected applications as well as the heat supply from the biogas engines of the three biogas power plants have been analysed. The simulation tool, cycle tempo has been used to simulate the thermodynamic performance of the selected applications. Regarding the selected applications the following conclusions can be drawn:

Organic Rankine Cycle (ORC)

- Use of ORC improves the overall electrical efficiency of the plant. However, a higher efficiency is obtained for larger biogas plant engine capacities compared to smaller plant capacities. The net efficiency increment varies between 2 and 5%. After the evaluating the additional investment vis-à-vis the tariff, it can then be possible to

establish whether use of ORC is a viable for the gas engines waste heat output streams under consideration. However, previous studies have shown that ORCs start making economic sense when used for biogas power plants larger than 500kWe.

- The power to heat ratio can be varied using Lambda (oxidant to fuel ratio). Lambda can hence be used to increase the share of thermal energy or electrical energy depending on which type of energy is more needed at a given hour of the day at a constant biogas flow rate.

Absorption cooling

- Absorption cooling applications have lower heat demands and therefore can even be used with heat supplies of smaller biogas plant capacities. Absorption cooling simulation was done by using the cooling of milk as an example. Single effect absorption chillers were considered in this simulation because a big percentage of the heat recovered is low quality heat (90°C) which favours their usage unlike double effect absorption chillers that use heat qualities of 150 to 180°C.

Greenhouses

- Greenhouses don't need to be heated in warm climate countries. There are rather a lot of heat gains during the day due to the high incident irradiation and therefore further cooling has to be done instead (for the crops considered; vegetables assumed in the simulation). A solar water collector system can be integrated with the greenhouses so as to capture and store the excess heat for use in other applications.

Drying digestate

- The drying application is highly heat intensive. The total heat generated was found not sufficient to dry all the digestate generated in year for the selected plants. Only a fraction less than 50% can be dried per year for each plant if back mixing technique is used. The water content in the digestate needs to be squeezed out before drying can occur.

5 References

- Aachen University, I. o. (2013). Adsorption Process. *Euro Heat and Power* .
- BASF. (25. January 2014). *Thermo Insulation of biogas plants*. Abgerufen am 26. January 2014 von BASF The Chemical Company: <http://www.styrodur.de>
- BCS. (2008). *Waste Heat Recovery: Technology and Opportunities*. US Department of Energy.
- Bini, R. *Organic Rankine Cycle in Biomass in Biomass Plants*. Brescia: Turboden Srl.
- Deland. (2013). *Deland Biogas Farmers anonymous*. Oldenburg: Deland Project.
- Dennis E . Buffington, R. A. (2013). *Greenhouse Ventilation*. Florida: University Of Florida.
- Druma, A. (1998). *Dynamic Climate Model of a Greenhouse*. Reykjavik: United Nations University.
- Earle, R. (1966). *Unit Operations in Food Processing*. accessed on 24. February 2014 von The New Zealand Institute of Food Science and Technology: <http://www.nzifst.org.nz/unitoperations>
- FNR. (2012). *Bioenergy Facts and Figures*. Niedersachsen: FNR e.V.
- Geveke, J. (2014). *Einsatzstofftagebuch*. Ihausen: Herr Geveke.
- Geveke, J. (2014). *Heat Uses Excel* . Ihause: Herr Geveke.
- Huopana, T. (2011). *Energy Efficient model of Biogas production in farmscale*. JYVÄSKYLÄ: University of Jyväskylä.
- IEA. (2007). *Biomass for power generation and CHP*. Paris: IEA.

IEA. (2012). *Solar Heating and cooling Technology Road Map*. Paris: IEA.

Ignace Vankeirsbilck, B. V. (2011). Energetical, Technical and Economical considerations choosing between a Steam and an Organic Rankine Cycle for Small Scale Power Generation. *First International Seminar on ORC power Systems* (S. 11). Delft: Ghent University.

JN. Ackerman, N. C. *Improving Anaerobic digestion efficiency for Hog manure in passive heating solar greenhouses on the Canadian Prairies*. Manitoba: Department of Biosystems Engineering , University of Manitoba.

Kamen, D. (2006). *Bioenergy and Agriculture: Promises and challenges*. Washington: The Energy and Resources Institute.

L.Barry Goss, L. S. (1980). *Factors Affecting Power Plant Waste Heat Utilisation* . Tenesse: Pergamon Press.

M. Gaderer, M. L. (2007). *Wärmenutzung bei kleinen landwirtschaftlichen Biogasanlagen*. Augsburg: Bayerisches Landesamt für Umwelt.

Nixon Energy, S. (5. February 2014). *Nixon Energy Solutions*. Abgerufen on 5. February 2014 from Nixon Energy Power Services: <http://nixonenergy.com/greenhouse.html>

Owen, M. (2009). *2009 ASHRAE Handbook Fundamentals*. Atlanta: American Society of Heating, Refrigeratng and Air-Conditioning Engineers Inc.

Peschel, J. (June 2008). *Drying digestate from biogas plants*. Abgerufen on 24. January 2014 from Thebioenergysite.con: <http://www.thebioenergysite.com/articles/94/drying-digestates-from-biogas-plants>

Poles, S. *Numerical Simulation of an Organic Rankine Cycle*. Montarello di Tretto: Open ring.

R.Andrews, J. P. (Issue 11. September 2011). Environment and Economic Assessment of a Greenhouse Waste Heat Exchange. *Journal of Cleaner Production* , 1446-1454.

R.K Shah, D. S. *Chapter 17: Heat Exchangers*. Kentucky: University of Kentucky.

Rutz, D. (2012). *Sustainable Heat Use of Biogas Plants*. Munich: WIP Renewable Energies.

Stecher, P. (1979). *Industrial and Institutional Waste Heat Recovery*. New Jersey: Noyes Data Corporation.

Stela.LaxhuberGmbH. (3. January 2014). *Stela drying technology*. accessed on 6. February 2014 from Stela drying technology: http://www.stela.de/portals/h1639318/story_docs/prospekte_englisch/stela_image_001_e_01_low.pdf

Toobox, E. (4. January 2002). *Engineering tool box*. accessed on 4. February 2014 von Air Properties: <http://www.engineerigtoolbox.com>

Verbeek, H. (2013). *Messprotokol*. Dornum: Herr Hayo Verbeek.

Verweyen, G. (2013). *Einsatztagebuch*. Dornum: Herr Verweyen.

Walker, J. (1970). *Greenhouse Ventilation Systems*. Kentucky: University of Kentucky.