

# MOSAIK - SMART GRID SIMULATION API

## *Toward a semantic based standard for interchanging Smart Grid simulations*

Steffen Schütte, Stefan Scherfke, Michael Sonnenschein

OFFIS, Escherweg 2, 26121 Oldenburg, Germany  
{schuette, scherfke, sonnenschein}@offis.de

**Keywords:** smart grid, co-simulation, coupling, semantic, simulation interface, domain-specific language, distributed simulation

**Abstract:** Simulation is an important method to test and evaluate new control mechanisms for future Smart Grids. To generate sound simulation results one has to use validated and established simulation models. In this paper we present the first two out of six layers of our approach to a modular simulation framework, called *mosaik*. It will allow to specify, compose and simulate Smart Grid scenarios based on the reuse of existing, technologically heterogeneous simulation models. The layers presented here include a syntactic layer defining an interface for Smart Grid simulators and a semantic layer implemented using a domain-specific language that allows to describe the structure and semantics of the simulator that is interfaced.

## 1 INTRODUCTION

Nowadays the electricity grid undergoes a large structural change toward a so-called Smart Grid, among other reasons triggered by the increased integration of renewable energy sources. In the future, the power grid will no longer be dominated by a relatively small number of large coal and nuclear power plants, but rather by a large number of dispersed, renewable energy sources (DER). The major problem thereby is the coordination of this large number of DER such that generation and demand are balanced at any time. This is a challenging task due to the number and restrictions of the involved components. Control strategies for this complex and new task still need to be developed and in particular evaluated and tested, for example with respect to grid stability or other scenario specific objectives. To ensure that this transition process can be done as economically as possible and especially without losing the reliability of today's grid, these control strategies need to be tested in simulated Smart Grid scenarios first.

In order to yield sound and scientifically reliable results, simulations have to rely on valid and (ideally) established models. As a consequence, a lot of effort is put into the modeling and validation of both single system components such as photovoltaics or wind energy converters and composite sub-systems, e.g. entire low or medium voltage power grids. Therefore, it is desirable to reuse existing models in new projects

and simulation studies as much as possible. However, a number of problems arises when reusing existing simulation models to form new Smart Grid scenarios.

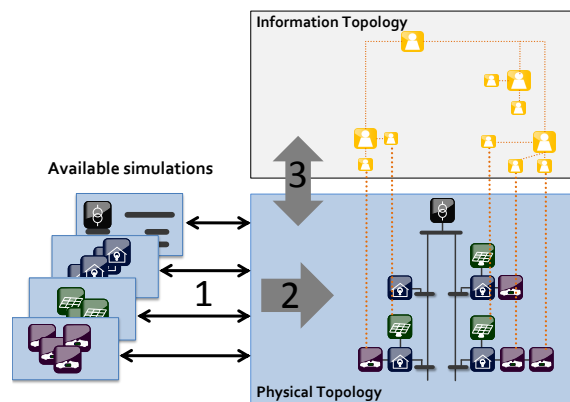

Figure 1: Identified problem areas

Figure 1 shows the problem areas that *mosaik* aims to solve. First, the available simulators are usually not designed to be reused (1). Therefore they do not offer any interface that is appropriate for interacting with the executed simulation. Second, one has to find a way to compose the different simulation models in a flexible way such that different scenarios can be composed and simulated (2). And finally, the composed simulation has to allow the interaction with control strategies (3). In our research we focus on the integration of multi-agent based control strategies which includes two major tasks. First, a standardized

API has to be offered to the agents such that different strategies and simulation models can be interchanged seamlessly. Second, a way to keep the agents synchronized with the simulation time has to be found, as multi-agent platforms are usually not made to work with simulated environments (Gehrke et al., 2008). To overcome these problems, we developed a concept called *mosaik* (Schütte et al., 2011) (Schütte, 2011b) which allows the automatic composition of Smart Grid scenarios as a test bed for control strategies based on the reuse of existing simulators. This also includes the use of available commercial simulation packages. Inspired by the M&S architecture proposed by (Zeigler et al., 2000, p. 496), the concept is based on six layers as shown in figure 2.

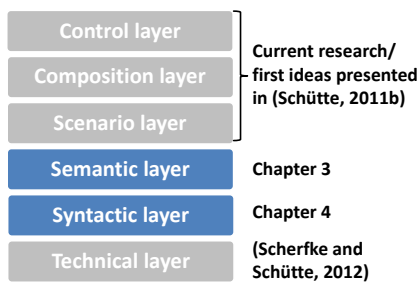

Figure 2: Layers of the mosaik concept

The technical layer provides a mechanism to find, initialize and manage the available simulators at runtime. The syntactical layer offers a generic simulator API to make simulators interoperable. The semantic layer formally describes parameter, models and entities of each simulator such that the semantic of the data exchanged via the generic API is unambiguous. The syntactic and semantic layer are described in detail in this paper. The formal simulator descriptions are then used in the scenario layer to formally describe Smart Grid scenarios. A scenario defines a certain composition and can also be used hierarchically in other scenarios. Finally, the composition layer performs the actual simulator composition based on the formal scenario and simulator descriptions, and the control layer allows to interact with the simulated entities at runtime.

The rest of the paper is organized as follows. In section 2 we present and discuss related work from the Smart Grid and other domains. Section 3 introduces the generic interface (SimAPI) proposed for the syntactic layer. Section 4 introduces the semantic layer. In this layer, the structure and semantic of each simulator implementing the SimAPI is described in a formal way using a domain-specific language (DSL) we have developed for this purpose. We demonstrate the usability of our SimAPI in section 5 by presenting a first simulation use case based on a prototypical im-

plementation. Finally, in section 6 we conclude by discussing the current results and planned future enhancements.

## 2 RELATED WORK

Different tools and approaches for simulating Smart Grid scenarios exist. (Karnouskos and Holanda, 2009) have “analyzed, designed, and built a simulator based on software agents that attempts to create the dynamic behavior of a smart city.” The advantages are the possibility to observe and manipulate the behavior of single entities (opposed to simulations that only operate on static load profiles) and as such the evaluation of a broad range of control strategies. As the simulation platform is based on the JADE agent framework (JADE, 2012) and the Smart Grid, due to its dispersed and large-scale nature, promotes the use of agent based control strategies, these can be integrated seamlessly into the simulator. However, the approach does not consider the integration of existing simulators/models, but rather requires to model all entities of a Smart Grid scenario as JADE agents. GridLAB-D (Chassin and Widergren, 2009) is a powerful simulation tool for power systems developed by the Pacific Northwest National Laboratory (PNNL) in cooperation with industrial partners. It allows the specification of a wide range of scenarios. However, compared to GridLAB-D, the mosaik concept is designed explicitly for the composition of heterogeneous simulation models by using formal, semantically enriched descriptions of the models and a powerful scenario specification formalism, allowing to specify large scenarios with little code.

To our knowledge, no simulation interoperability standard specific to the Smart Grid domain exists. Up to now, the military domain has been a major driver for the development of simulation interoperability standards starting in the early 90s. This need was initially triggered by the “need for a common ‘synthetic environment’ that could interconnect simulators in support of small-team training”. This can be compared to today’s online games (Page, 2007). The latest standard for distributed simulation that has evolved from these efforts is the HLA. This standard is very complex and thus hardly used outside the military domain (Boer et al., 2008). We argue that this is also true for Smart Grid simulations for the purpose of evaluating and benchmarking control strategies for distributed energy resources such as photovoltaics (PV), electric vehicles (EV) and other controllable devices, as “new approaches [for simulation interoperability] are unlikely to be accepted

by the M&S industry if they are connected with tremendous migration costs due to reprogramming efforts” (Tolk and Muguira, 2004). Therefore we present a very lightweight interoperability solution for Smart Grid simulation.

In the field of environmental sciences the OpenMI (Gijbbers and Gregersen, 2005) standard is a successful example for a lightweight and pragmatic approach (which has been developed although the HLA was already an IEEE standard when the work on OpenMI began)<sup>1</sup>. However, there are fundamental differences to the Smart Grid domain making the OpenMI approach of manually connecting different models inapplicable. Usually, few uncontrollable models with complex interdependencies (e.g. a river and a groundwater model) are analyzed in the environmental domain while many models of potentially controllable energy resources with topological relationships characterize the Smart Grid domain. Therefore, we decided to develop a Smart Grid specific solution that allows (1) interfacing and semantically describing simulators and their models (presented in this paper), (2) describing potentially large-scale Smart Grid scenarios and (3) automatically composing these scenarios using the available simulation models for purpose of evaluating control strategies (beyond the scope of this paper).

### 3 SYNTACTIC LAYER - SIMAPI

In this section we describe the requirements and design of a simulator API that we developed to achieve basic, syntactic interoperability between the different simulators.

#### 3.1 Requirements

Although the SimAPI presented in this paper is not Smart Grid specific in a technical way, we developed it based on the analysis of different Smart Grid scenarios we simulated in past projects and expect for future projects. We identified three major requirements that influenced the design of the SimAPI.

##### 3.1.1 COTS Integration

As mentioned in the introduction it is important to rely on valid and (ideally) established models. This is especially true for the simulation models used for

the electrical infrastructure. For these models, different (commercial-off-the-shelf) COTS simulators exist that have been used in industry and academia for a long time. Therefore, the mosaik framework should support the integration of such closed-source software packages as well. For the syntactical layer, the SimAPI should also be applicable to COTS simulators, e.g. by implementing an adapter that mediates between the SimAPI and API of the COTS component.

##### 3.1.2 Control Strategy Integration

Control strategies for all kinds of power grid resources starting from a circuit breaker up to a pool of several thousand electric vehicles are the major components that distinguish the vision of the Smart Grid from today’s less controlled power grid. For being able to use composed simulation models as a test-bed for the evaluation of new control strategies the SimAPI has to provide information about the entity relationships within a model.

For example, assume that we have the model of a power grid comprised of an MV grid and different LV grids. It has entities for transformers, buses (nodes) and branches (power lines). Further we have different models of controllable consumers and producers. Now we want to use these models to form a simulative scenario for assessing the performance of a new multi-agent based control strategy. For such multi-agent systems, different organization forms exist (Horling and Lesser, 2004). Let us assume we have one agent per transformer (transformer agent) and subordinate to this, one agent per controllable resource (resource agent) in the subordinate LV grid section and we have initialized the simulation models by now. However, for initializing the agent system, we need to know what resource agents are related to which transformer agent.

Assuming that the grid topology is described by a specific file, one way to get this information is to include a parser into the control strategy code which can read this file so that the grid topology can be navigated for initializing the agents in the right topology. However, different grid models may use different file formats which makes it difficult to use other grid models in this scenario and the parser code is more or less redundant as the grid model has this information anyway. Therefore we extended the SimAPI to provide information about the model’s entity relationships. This way, we can easily determine which nodes are (via the branches) related to which transformer just by querying the model without having to parse any other files.

<sup>1</sup>[http://www.openmi.org/documents/OpenMI\\_Newsletter1\\_0405.pdf](http://www.openmi.org/documents/OpenMI_Newsletter1_0405.pdf)

### 3.1.3 Simulation Result Analysis

For being able to evaluate the performance of a control strategy, different metrics (e.g. resource utilization) have to be calculated. The calculation of these metrics is usually done based on the simulation results (entity data that has been recorded during simulation). For example, the maximum load of a transformer or the maximum current through a power line could be a possible metric. But how do we know what thresholds are permissible? One way is to hard code the values into the metric. However, it is much better to obtain these values directly from the entity in question. Therefore, the API must provide access to such data describing static properties of the entities.

## 3.2 Abstraction Level

The syntactical layer is the lowest layer of our concept, determining the possible interactions with the simulation models. Therefore, a suitable abstraction level has to be chosen for the simulator API that allows the integration of a broad range of simulation models as well as sufficient flexibility and detail for using these in different scenarios, while at the same time being as simple as possible to minimize integration effort and improve acceptance of the SimAPI. As the mosaik framework focuses on the composition of discrete event simulation models (Schütte et al., 2011), the lowest reasonable abstraction level is the DEVS formalism introduced by Zeigler (Zeigler, 1976). Although such a low-level abstraction provides maximum flexibility, a number of disadvantages arises. First of all, for the integration of a simulation model (implementing the SimAPI for this simulator) on this low abstraction level all low-level information (internal states, state transitions, events, etc.) has to be integrated into the SimAPI as well as described in a formal way (see next chapter) to make it available for the composition. Implementing such a complex API is time consuming, error prone and likely to be rejected by the users as “new approaches are unlikely to be accepted [...] if they are connected with tremendous migration costs due to programming efforts.” (Tolk and Muguira, 2004) Furthermore, the integration of simulation models based on COTS simulation packages (see 3.1.1) is not likely to be possible on this low abstraction level as such simulation packages are usually not “open” (Boer, 2005). Regarding the last point, (Boer, 2005) did extensive research upon distributed simulation in industry and defines three different levels of “openness” of COTS simulation packages: “fully open”, “partly open” and “fully

closed”. A fully open simulation package is a simulation package that allows access to all entities and their attributes at every step in time. (Boer, 2005) states that according to this definition most of the available simulation packages are only partly open. (Boer, 2005) therefore also uses a higher abstraction than the DEVS formalism and only focuses on the entities and their attributes without considering the internal processes and events. (Zhang et al., 2005, p.3) use a similar abstraction level since their approach for oil reservoir performance forecasting is also based on existing software and thus is “not concerned with modeling the internal structures or implementation of the building software components.” Instead they “only capture the interfaces [of the components] each of which can be characterized with a set of input signals and a set of output signals”.

**Assumption: An abstraction level as detailed as the DEVS formalism is not required for composing the majority of Smart Grid scenarios.**

On the other end of the scale a complete black box view of a simulator could be assumed. Such an API may only allow to read and manipulate certain attributes of a simulation and advance the simulation time step by step. Such an API is likely to be too restricted.

## 3.3 Resulting Design

Based on the analysis of different simulation models we developed in our past Smart Grid projects, we decided to let our SimAPI deal with 3 different concepts:

1. **Entity** - Any object or component in the modeled system that requires explicit representation (e.g. a transformer, a power line, an electric vehicle) (Banks et al., 2005)
2. **Model** - A (simulation) model is an abstract representation of a system and is executed by a simulation environment (e.g. a model of a low voltage grid).
3. **Simulator** - A simulator is the execution environment for one or more models (in this paper, the term simulation refers to a simulator, executing its simulation models).

In other words, a simulator can contain one or more models which again contain one or more entities, representing objects in the real world. The SimAPI has to account for this structure and allow to specify the parameters for the simulator (start time,

step size, etc...), the number and configuration of the models to execute as well as to access (read and write) the attributes of the entities contained in the models. Entities cannot be simulated directly but rather are the result of initializing a model in the simulator. The possible step sizes of a simulation, the number of models the simulator can handle and other non-syntactic information will be part of the semantic description of the simulator (see next chapter). Figure 3 shows the structure of a simulator and the data that is made accessible by the SimAPI (arrows crossing the black box).

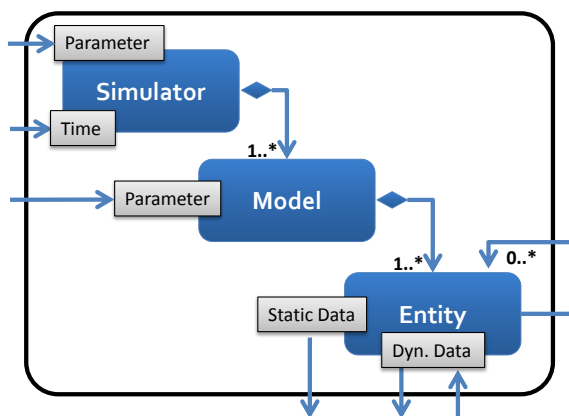

Figure 3: Simulation features exposed by the API

### 3.4 Implementation

The mosaik SimAPI is designed to be very generic and flexible which allows a wide range of simulations to be used with it. We use ØMQ (ZeroMQ) as a message transport layer and JSON (JavaScript Object Notation) for object serialization. ØMQ is fast, well-documented, available on a wide range of platforms (including Python, Java, C/C++) and freely available under the *Lesser General Public License (LGPL)* (iMatix Corporation, 2012). JSON “is a lightweight data-interchange format”. It is much more compact and less verbose than XML and thus easier and faster to read and parse (JSON, 2012). As opposed to e.g. XML/RPC (Remote Procedure Calls with XML serialization) which we used in an earlier prototype, using ØMQ/JSON also allows us to asynchronously handle multiple simulations at once without the need for threading and locking. The mosaik framework currently offers a SimAPI adapter for simulations written in Python. We also aim to provide adapters for at least Java and C. The SimAPI adapters provided by mosaik offer an interface for the SimAPI calls and take care of the serialization of messages and the communication with the mosaik framework (or any other client).

#### 3.4.1 SimAPI Methods

The SimAPI consists of the following methods:

**init** (*step\_size*, *sim\_params*, *model\_config*):

Initializes a simulation and creates model instances. *model\_config* contains a list of tuples providing information about how many instances of what model have to be initialized with which parameter values.

**get\_relations** ():

Returns a list of tuples for each entity relation. Each tuple contains a pair of related entities (their IDs).

**get\_static\_data** ():

Returns the values of all static attributes for all entities. Static attributes are attributes that don’t change during the execution of the simulation.

**get\_data** (*model\_name*, *etype*, *attributes*):

This methods returns the current values for all attributes in *attributes* for all *etype* typed entities of the model *model\_name*.

**set\_data** (*data*):

Sets the values of the given attributes for each entity in *data*, a list of tuples of an entity ID and new attribute values for this entity.

**step** ():

Advances the simulation by *step\_size* steps (as defined in the *init* method) and returns the current simulation time.

#### 3.4.2 The low-level communication protocol

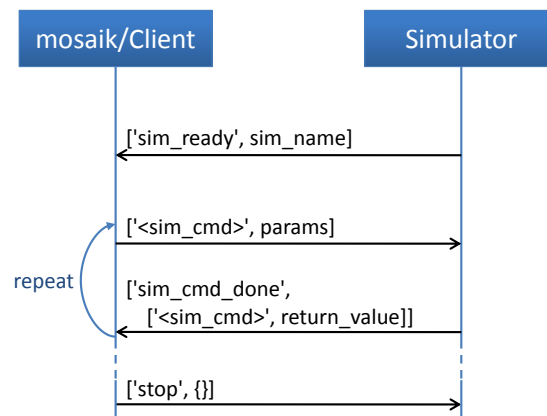

Figure 4: The communication sequence between a simulation and a client (e.g. mosaik).

When a simulator has been started, it has to signal the client (e.g. the mosaik framework) when it is

ready to receive commands. The client can then do any number of SimAPI calls, that is sending simulator commands and receiving their return value. When the client is done, it sends a stop message, so that the simulator can cleanly shut down itself.

Each message sent is a tuple containing the message type (that is equivalent to the SimAPI method name) and a dictionary with data which will be mapped to the method parameters (see previous section). Note that the client can send commands to multiple simulations at the same time and asynchronously receive their replies. Figure 4 visualizes the communication sequences between the simulator and a client.

## 4 SEMANTIC LAYER

In the last section we defined a generic simulator API, i.e. methods and their signature do not change from one simulator to another. It allows to initialize, execute and access a simulator and its models and entities. Such a generic API is beneficial to integrate new simulators into a simulation composition engine without changing its implementation. But to allow the engine and/or human clients to make correct use of the simulators, additional information about the following aspects of the SimAPI is required:

- What step sizes does the simulator support?
- What parameters are available for the simulator and the models?
- What is their data type and what values are permissible?
- Which and how many models can a simulation execute?
- How many models can a simulator execute and can they have different parameter configurations?
- What entities does a model contain?
- What is the structure of the entities I/O-data?
- What static data is available?

We propose a domain-specific language (DSL) called *mosl* (mosaik specification language) that is tailored specifically for this purpose and allows to describe all these different aspects of a simulation in a formal, human and machine readable way. We implemented our DSL using the Xtext framework which is available as a plugin for the Eclipse IDE. Both, Xtext and Eclipse are freely available. Compared to an XML based approach, for example, Xtext offers a DSL specific editor with advanced consistency checks, auto-completion, syntax highlighting and furthermore the DSL has a custom syntax and is thus less

verbose (see (Xtext, 2011)).

Regarding the non-technical aspects, we try to make use of the Common Information Model (CIM) whenever it is possible and appropriate. The CIM provides a large information model for the energy domain and is standardized by standards series IEC<sup>2</sup> 61970 and 61968. It is also recommended as one of the core standards for the future smart grid (NIST, 2010).

Listing 1 shows the basic structure of our DSL using the example of a PowerFlow Simulator as we used it in our first case study (see section 5). Although it is very simple, it already covers a number of the aspects listed above. Each simulator is described in a separate file.

Listing 1: Basic simulation definition

```

simulator PowerFlow stepsize [1,] sec
  model 1..* StaticPowerFlow
    entity Bus
    end
    entity Branch
    end
    entity Transformer
    end
  end
end

```

It allows to define a simulation and the valid step sizes for this simulation as well as the possible models the simulation can execute. For each model, the possible number of instances the simulation can execute can be defined (1 or more in the example), and the entity types that the model contains are defined as well. In the next sections we introduce the other concepts of the DSL to define the remaining aspects of the simulation based on this basic structure.

### 4.1 SIMULATION AND MODEL PARAMETER

An important part of the DSL is the definition of configuration parameters on both, simulation and model level. A formal and standardized description of the parameters as well as the standardized SimAPI to set these parameters will ease model reuse, as the configuration of all participating simulators is specified in a central place. According to our experience this is an important point for increasing the usability of composed simulations. Up to now, each simulator had to be configured using its proprietary configuration file format and location, making it very difficult to keep track of the simulator configurations used for a scenario. Listing 2 shows the parameter description using the example of an EV simulation.

<sup>2</sup>International Electrotechnical Commission

Listing 2: Parameter definition

```

simulator EVSim stepsize {1,15} min
  start:datetime
  stop:datetime

model 1..* identical EVModel
  p_charge : float in W
    {3700.0,11000.0}
  c_bat    : float in Wh [1.0,]
  init_soc : float in percent
    [0.0,1.0] default = 0.5

  entity Vehicle
end
end
end

```

The definition of a parameter begins with a name and a colon, followed by a data type. Currently, possible types are *int*, *float*, *string*, *boolean* and *datetime*. For numerical types an additional unit can be specified using the ‘in’ keyword. The units that are available have been extracted from the enumeration *UnitSymbol* defined in the *Domain* package of the CIM. For numerical types and the string type, the definition of valid values is possible by either using square brackets to specify a range or using curly brackets to define a discrete set of allowed values. The definition of a default value indicates the value that is used by the model or the simulation when the parameter is not provided via the SimAPI. The keyword *identical* indicates that a single simulation can only simulate the given number of models with the same configuration parameters, i.e. the simulation described above cannot simulate vehicles with different battery sizes.

## 4.2 DATA FLOW AND COMPOSITION

As already stated in the introduction, the work presented here is part of a larger concept (see figure 2) which will allow the automatic composition of different simulation models to form different Smart Grid scenarios. Therefore, a model will usually be used in combination with other models. This means that the inputs and outputs of the different entities of the models have to be connected. For example, the power drawn by an EV, which is provided by the Bus entity as output value, is an input value for the Bus entity which represents the node in the grid the EV is connected to.

### 4.2.1 Reference Data Model

In order to allow such an automatic mapping, we propose the use of a reference data model that is used for defining the entities’ inputs and outputs. Without such a reference model a manual mapping would be required between every possible combination of entities. By using the reference model this  $O(n^2)$  problem is reduced to an  $O(n)$  problem (Tolk and Diallo, 2005, p.67) as the entities of a simulation model only have to be adapted to the reference model (see figure 5). This adaption has to be done when implementing and semantically describing the SimAPI. To base our data model on a standardized and thus wide-spread and solid basis we make again use of data structures defined in the CIM whenever possible.

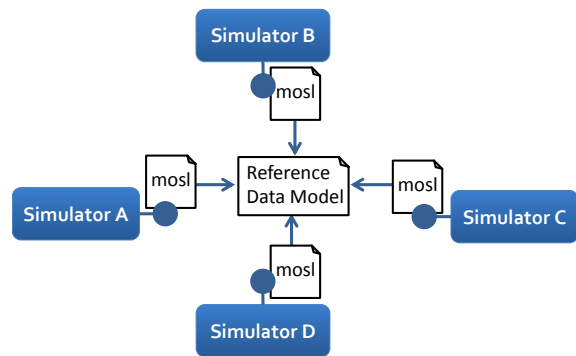

Figure 5: Reference data model for semantic description of simulator interfaces

The structure of the data that is consumed or provided by the entities (data flow) is of different complexity. For example, information about the state of charge (SOC) of a vehicle’s battery may be a simple float value whereas the voltage of a node is a tuple of voltage and angle and the power drawn by a consumer is a tuple of active and reactive power. An EV or other potentially controllable resources may also be able to receive more complex data structures such as operating schedules.

We have extended our DSL to allow the definition of a reference data model with such complex structures by using a subset of the JSON-Schema (JSON-Schema, 2012) specification. However, to keep our DSL as readable and non-verbose as possible, we chose not to use the JSON-Schema syntax but rather a compatible notation syntax called *Orderly* (Orderly, 2012). This part of our DSL is based on an available Xtext implementation of Orderly (Github, 2012), with one exception: Orderly uses curly brackets to specify a range of allowed values. We decided to stick to our syntax (using square brackets for ranges and curly brackets for sets of allowed values) as this seems much more

intuitive and is well known from set theory. Listing 3 shows the definitions of the different entity data flow structures discussed above using our DSL.

Listing 3: Reference Data Model

```
reference data model de.offis.mosaik
data flows
  //IEC61970.StateVariables.SvPowerFlow
  @Equals(voltageLevel)
  SvPowerflow:object {
    p:float in W
    q:float in W
  }

  //IEC61970.StateVariables.SvVoltage
  SvVoltage:object {
    angle:float in rad
    v      :float in V
  }
  current:float in A
  stateOfCharge:float in percent
    [0.0,1.0]

  v2g_schedule:object {
    startTime:datetime
    timePoints:array [object {
      time      :integer in s
      duration:integer in s
      command  :string {idle, charge,
        discharge}
      power    :float in W [0.0,]
    }]
  }
end
static data
  voltageLevel:string {LV, MV, HV}
  //From IEC61970.OperationalLimits
  CurrentLimit:float in A
end
entity types //From IEC61970.Wires
  ACLineSegment:Conductor
  Conductor
  BusbarSection:Connector
  Connector
  Junction:Connector
end
end
```

The `v2g_schedule` data, for example, is a complex data type (object) with two fields. The field `startTime` is a simple type representing a date, the field `timePoints` is a list (array) of complex data types each of which having the 4 fields `time`, `duration`, `command` and `power`.

For the `SvPowerflow` and `SvVoltage` items we have used the structures defined in the CIM. For the other data, custom structures have been created. In addition to the definition of the data structures, the reference model also allows to define static data for the entities. As mentioned in 3.1.3, we define static data as

any data that describes an entity but does not change over time. Besides using this static data when analyzing the simulated scenario (see section 3.1.3) it can also be used to specify domain-specific data flow constraints using the `@Equals` keyword. In this example, we have defined that the voltage level of entities interchanging `SvPowerflow` data must be the same. For example, it must not be possible to connect an EV (assuming EVs charge at the low voltage level) to a bus in a medium voltage grid. As both entities have to have the same attribute, it is defined in the reference data model as well, but within a special static data section. The static data items can have the same complex structure as the other items. Finally, the `entity types` section allows to define a hierarchy of abstract entity types. In our case the object hierarchy defined in the IEC61970 package `Wires` is an appropriate option. The usage of these abstract entity types is described in the next section.

The reference data model defines a unique namespace (here: `de.offis.mosaik`) as it is unlikely that a globally standardized reference model will ever be available. Using distinct namespaces, simulators from different sources (companies) can be used together without mixing up data model elements with the same name. Of course, in such cases a mapping between the used reference data models has to be defined. However, this is beyond the scope of the paper and subject to future work.

#### 4.2.2 Using the Reference Model

The `mosaik` scenario layer (see figure 2) will allow to specify relations between the entities of different simulators. Based on the semantic information in the simulator description the data flows between any two related entities shall then be derived automatically to ease composition. The elements of the reference data model provide the base for this process. They can be referenced from within the simulator descriptions by importing the corresponding namespace. The `Xtext` framework natively supports the concept of namespaces so that no further manual implementation is required. Listing 4 shows the final simulator description for `PowerFlow` and `EV` simulator used in one of our projects (see next section).

Defining the static data offered by the entities is straight forward. It is simply defined using the `static` keyword followed by a static data item from the reference data model. As with all other references, the DSL editor generated by `Xtext` allows the user to use only those elements that are defined in the reference data model and thus supports the user in creating a consistent simulator definition.



Listing 4: Defining static and dynamic data

```

import de.offis.mosaik.*
simulator EVSim stepsize {1,15} min
model 1..* identical EVModel
  entity Vehicle
    static voltageLevel
    port for 1 Connector
      out grid_power:SvPowerFlow
    end
    port
      control:v2g_schedule
    end
  end
end
end

simulator PowerFlow stepsize [1,] sec
model 1..* StaticPowerFlow
  entity Bus:Connector
    static voltageLevel
    port for 0..*//Can have n loads
      in load:SvPowerflow
    end
  end
end
  entity Branch:ACLineSegment
    static CurrentLimit
    port
      out i_branch:current
    end
  end
end
  entity SlackNode:PowerTransformer
    static voltageLevel//Primary side
    port
      out load:SvPowerflow
    end
  end
end
end
end

```

The dynamic data flow definition is slightly more complex as these flows are the basis for simulation composability. Generally, two entities (of models from different simulators) can be connected when one entity provides a data flow defined in the reference data model and the other consumes it. To describe these flow directions, each data flow is given a direction in the simulator description using either the *in* or the *out* keyword. In case of an EV being connected to a node in the power grid the EV will have an outgoing flow (the power it draws from the grid) and the grid node has to provide an incoming flow. Furthermore, the allowed multiplicity for incoming flows can be specified (depending on the type/capabilities of the simulation model). In our example, it may be possible to connect multiple EVs to the same bus. In this case it is the task of the simulator to aggregate the numerous incoming flows to a meaningful value for the underlying model entity.

Figure 6 shows a more complex scenario with an EV

having power flows to a bus (power drawn) and a battery model (power drawn/charged). For both flows, the same data item *power* is used. Note that this is different to the reference model presented in listing 3 but used for illustration purposes. With the concepts defined so far, each outgoing flow of the EV can be connected to both, the bus as well as the battery, as the *power* flow is more abstract than our *SvPowerFlow* which is to be used for AC power flows only<sup>3</sup>. This is a general problem: A more abstract flow increases the combination possibilities of an entity but also increases semantic ambiguity. Of course, one solution to this dilemma is to define different data flows for AC (bus) and DC (battery). However it does not tackle the general problem, which is a lack of semantic. As mentioned before, data flows should be as abstract as possible to increase combination possibilities. We therefore added the concept of abstract entities (see last section in listing 3) and introduced the notion of ports. A port serves the purpose of grouping all flows that are to be connected to an entity of a certain type (or all types if no type is specified). The type of an entity is specified after its name using a colon. In the example shown in figure 6, the EV entity defines two ports: one for the connection to a *Connector* in power grid and another for connecting the EV to a *Storage* entity.

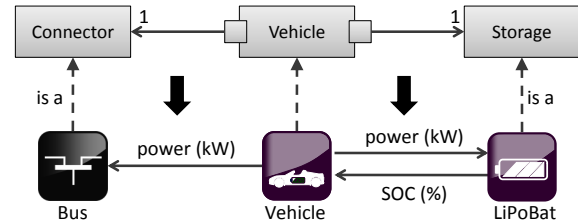

Figure 6: Port based entity composition

A port of an entity A can be connected to another entity B when: (1) A has a port accepting B and B has a port accepting A, (2) all incoming flows of each port can be satisfied (i.e. type and direction match) and (3) the domain specific data flow constraints are fulfilled. Now the data flows can be established unambiguously when composing the entities as shown in the bottom part of figure 6. To avoid specifying the multiplicity for incoming flows multiple times it has been moved to the port definition as well.

<sup>3</sup>Note: *SvPowerFlow* can still be used on different voltage levels but we therefore added the *@Equals* constraint in the data model.

## 5 A FIRST USE CASE

Within the eMobility project GridSurfer (BMW, 2010), different simulators implementing the SimAPI, as it has been presented here, have already been successfully composed for the evaluation of electric vehicle charging strategies (Nieße et al., 2011). For this purpose, simulation models of electric vehicles (Python/SimPy), photovoltaics (MATLAB/Simulink), residential loads (CSV timeseries) and two different distribution grids (rural and city for a single-phase power flow simulator based on Python/Pylon (Pylon, 2012)) have been composed into a complex scenario. The analyzed scenarios contained about 70 to 100 residential loads and PV systems and 100 to 170 EVs, depending on the specific scenario. Figure 7 depicts the topology of the used low voltage grid for the rural scenarios and the entities of the different simulators that have been integrated.

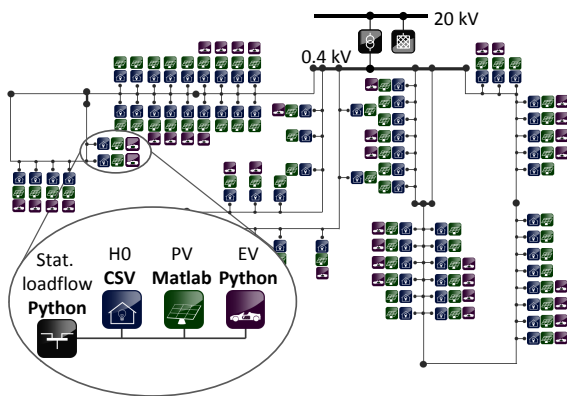

Figure 7: Topology of the simulated rural LV grid

However, we only used a less powerful and flexible prototypical implementation of the mosaik layers (figure 2) as partially described in (Schütte, 2011a). The consequences, for example, were a hard coded control and data flow (execution order and I/O-mapping) for the participating simulations. We described the next generation of the semantic layer in this paper and the remaining layers (scenario, composition and control layer) are subject to current and future work. The mosaik framework will then be able to dynamically determine the control and data flow as well as to synchronize with potentially connected, agent-based control strategies. Nevertheless, we obtained different interesting results regarding the integration of renewable energy feed-in for the different scenarios that we analyzed. We evaluated three charging strategies for electric vehicles, namely *uncontrolled charging*, *controlled charging* and *vehicle-to-grid* regarding their ability to store local feed-in

from photovoltaic power plants. Figure 8 shows the aggregated and averaged results from several simulation runs of the specified scenario. Since both the uncontrolled and controlled charging strategy don't take the vehicles' batteries ability to feed electric power back to the grid into account, they can only use small shares of PV feed-in (i.e., the electric power previously used for driving). In contrast, the vehicle-to-grid agents fully exploit the batteries' capabilities, thus significantly increasing the percentage of used PV feed-in.

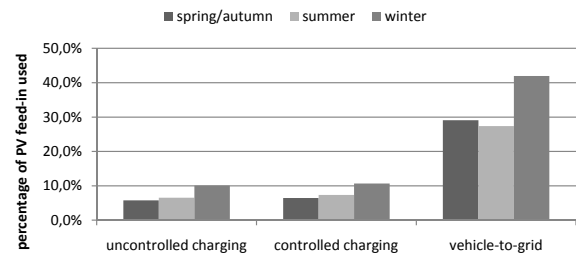

Figure 8: Percentage of local PV feed-in stored by electric vehicles in a low voltage distribution grid using different control strategies.

## 6 CONCLUSIONS

The work presented here is, according to our knowledge, the first attempt toward a Smart Grid specific standard for simulation model exchange and interoperability. The generic SimAPI is intentionally kept simple but allows to use a simulation for a broad range of scenarios and provides a standardized way to communicate with simulators. The formal description of each simulator's API using the presented DSL serves as a documentation and as the basis for an automatic composition of simulated Smart Grid scenarios likewise. A concept for the latter has been presented in (Schütte et al., 2011) and a corresponding extension of the DSL that will allow to describe complex scenarios based on different simulations in a formal way is currently under development. An in depth evaluation of the overall mosaik concept will follow once this extension is available. Due to its high abstraction level, the SimAPI will also be applicable to COTS simulation tools. We currently develop such an adapter for the broadly used tool PowerFactory (DiGSILENT, 2012). As the composability of simulation models depends on the use of a common reference data model, it will be beneficial to have a reference data model that is not specific to a single institute or company. Therefore, our work presented in this paper, as well as the overall mosaik concept, will also be presented to the

Simulations Working Group of the Open Smart Grid International Users Group (OpenSG, 2012), in which one of the authors is actively involved right from the beginning.

## REFERENCES

- Banks, J., Carson, J. S., Nelson, B. L., and Nicol, D. M. (2005). *Discrete-Event Simulation*. Prentice Hall, 4th edition.
- BMWi (2010). Gridsurfer - inter-urbane integration von elektrofahrzeugen in energiesysteme inklusive batterie-wechselkonzept. <http://www.ikt-em.de/de/GridSurfer.php>.
- Boer, C. A. (2005). *Distributed Simulation in Industry*. PhD thesis, Erasmus University Rotterdam.
- Boer, C. A., de Bruin, A., and Verbraeck, A. (2008). Distributed simulation in industry - a survey part 3 - the hla standard in industry. In *Proceedings of the 2008 Winter Simulation Conference*, pages 1094–1102.
- Chassin, D. P. and Widergren, S. E. (2009). Market operations. *Power & Energy Society General Meeting, 2009. Pes '09*, pages 1–5.
- DiGSILENT (2012). DIgSILENT GmbH - software - digsilent powerfactory. [http://www.digsilent.de/Software/DIGSILENT\\_PowerFactory/](http://www.digsilent.de/Software/DIGSILENT_PowerFactory/).
- Gehrke, J. D., Schuldt, A., and Werner, S. (2008). Designing a Simulation Middleware for FIPA Multiagent Systems. In *2008 IEEE/WIC/ACM International Conference on Web Intelligence and Intelligent Agent Technology*, pages 109–113. IEEE.
- Gijsbers, P. J. A. and Gregersen, J. B. (2005). The OpenMI Standard in a nutshell. [http://www.openmi-life.org/downloads/documentation/the\\\_openmi\\\_standard\\\_in\\\_a\\\_nutshell.pdf](http://www.openmi-life.org/downloads/documentation/the\_openmi\_standard\_in\_a\_nutshell.pdf).
- GitHub (2012). crealytics/orderly-json-xtext - GitHub. [https://github.com/crealytics/orderly\\\_json\\\_xtext](https://github.com/crealytics/orderly\_json\_xtext).
- Horling, B. and Lesser, V. (2004). A survey of multi-agent organizational paradigms. *Knowl. Eng. Rev.*, 19:281–316.
- iMatix Corporation (2012). ZeroMQ – the intelligent transport layer. <http://www.zeromq.org/>.
- JADE (2012). JADE - Java Agent DEvelopment Framework. <http://jade.tilab.com/>.
- JSON (2012). Introducing JSON. <http://www.json.org/>.
- JSON-Schema (2012). Json schema. <http://json-schema.org>.
- Karnouskos, S. and Holanda, T. N. D. (2009). Simulation of a Smart Grid City with Software Agents. *2009 Third UKSim European Symposium on Computer Modeling and Simulation*, pages 424–429.
- Nieße, A., Tröschel, M., Scherfke, S., Schütte, S., and Sonnenschein, M. (2011). Using electric vehicle charging strategies to maximize pv-integration in the low voltage grid. In *6th International Renewable Energy Storage Conference and Exhibition (IRES 2011)*.
- NIST (2010). NIST framework and roadmap for smart grid interoperability standards, release 1.0. nist special publication 1108.
- OpenSG (2012). Home - SG Simulations. [http://osgug.ucaiug.org/SG\\_Sim](http://osgug.ucaiug.org/SG_Sim).
- Orderly (2012). Orderly JSON. <http://orderly-json.org/>.
- Page, E. H. (2007). Theory and practice for simulation interconnection: Interoperability and composability in defense simulation. In Fishwick, P. A., editor, *CRC Handbook of Dynamic System Modeling*, chapter 16. CRC Press.
- Pylon (2012). Welcome - pylon home. <http://rwl.github.com/pylon/pylon/>.
- Scherfke, S. and Schütte, S. (2012). mosaik - simulation engine architecture. [http://mosaik.offis.de/downloads/mosaik\\_architecture\\_2012.pdf](http://mosaik.offis.de/downloads/mosaik_architecture_2012.pdf).
- Schütte, S. (2011a). A domain-specific language for simulation composition. In Burczynski, T., Kolodziej, J., Byrski, A., and Carvalho, M., editors, *25th European Conference on Modelling and Simulation*, pages 146–152, Krakow.
- Schütte, S. (2011b). Composition of simulations for the analysis of smart grid scenarios. In *Energieinformatik 2011*, pages 53–64. Prof. Dr. Dr. h.c. H.-Jürgen Appellrath, Clemens von Dinther, Lilia Filipova-Neumann, Astrid Nieße, Prof. Dr. Michael Sonnenschein and Christof Weinhardt.
- Schütte, S., Scherfke, S., and Tröschel, M. (2011). Mosaik: A framework for modular simulation of active components in smart grids. In *1st International Workshop on Smart Grid Modeling and Simulation (SGMS)*, pages 55–60. IEEE.
- Tolk, A. and Diallo, S. (2005). Model-Based Data Engineering for Web Services. *IEEE Internet Computing*, 9(4):65–70.
- Tolk, A. and Muguira, J. A. (2004). M&s within the model driven architecture. In *Interservice/Industry Training, Simulation, and Education Conference (IITSEC)*.
- Xtext (2011). Xtext 2.0 documentation. [http://www.eclipse.org/Xtext/documentation/2\\_0\\_0/000-introduction.php#DSL](http://www.eclipse.org/Xtext/documentation/2_0_0/000-introduction.php#DSL).
- Zeigler, B. P. (1976). *Theory of Modelling and Simulation*. Wiley & Sons, New York.
- Zeigler, B. P., Kim, T. G., and Praehofer, H. (2000). *Theory of Modeling and Simulation*. Academic Press, New York, 2nd edition.
- Zhang, C., Prasanna, V., Orangi, A., Da Sie, W., and Kwatra, A. (2005). Modeling methodology for application development in petroleum industry. *IRI - 2005 IEEE International Conference on Information Reuse and Integration.*, pages 445–451.